

Magnet drive gear pumps MK200/MK300/MK500 series

The MK200, MK300 and the MK500 series pumps are designed to complete the existing MG series with improved performances in terms of capability to handle high viscosity fluids and a wider offer of materials to suit most applications, from the food to the industrial and chemical markets. The pump's housing and the internal metal parts are available in AISI 303, AISI 316L or SAF 2205.

The gears are available in Peek™, Ceramic Peek™ or PTFE™.

The driving magnet and the quality of the materials of the assembled components allows handling of fluids with temperatures up to 120 °C (248 F).

The low noise and pulsation is the result of precision gears accurately assembled and balanced within the housing combined with the magnetic coupling which grants the perfect alignment.

The Sanitary design makes this pump series the preferred candidate for use in medical applications where trouble-free products are needed.

It is also available a special version designed for system pressure up to 35 bar (507 psi).

Available upon request:

- Built-in relief valve (MK200 series only)



MAIN APPLICATIONS

- Medical and surgical equipment
- Hemodialysis apparatus
- Laser apparatus
- Lubrication
- Ink-Jet printing systems
- Cooling systems
- Laboratory instrumentation
- Water treatment
- Sampling
- Food processing equipment
- Sanitization



TECHNICAL INFORMATION

Pump housing material	Stainless steel	Max static pressure	20 bar/290 psi
Gears and bushing materials	Peek™/Ceramic Peek™/PTFE™	Temperature range	Peek™ -45 to 120 °C/-49 to 248 F
Ports	1/4" GAS or NPT	Temperature range	Ceramic Peek™ -45 to 120 °C/-49 to 248 F
Pump weight (MK313)	700 g (1.5 lb)	Temperature range	PTFE™ -45 to 50 °C/-49 to 122 F
Speed limit	5000 rpm	Max vacuum	724 mmHg/28.5 inHg
*Wet lift with water	~ 8m/26.7 ft		

* Priming ability varies with operating conditions and fluid characteristics

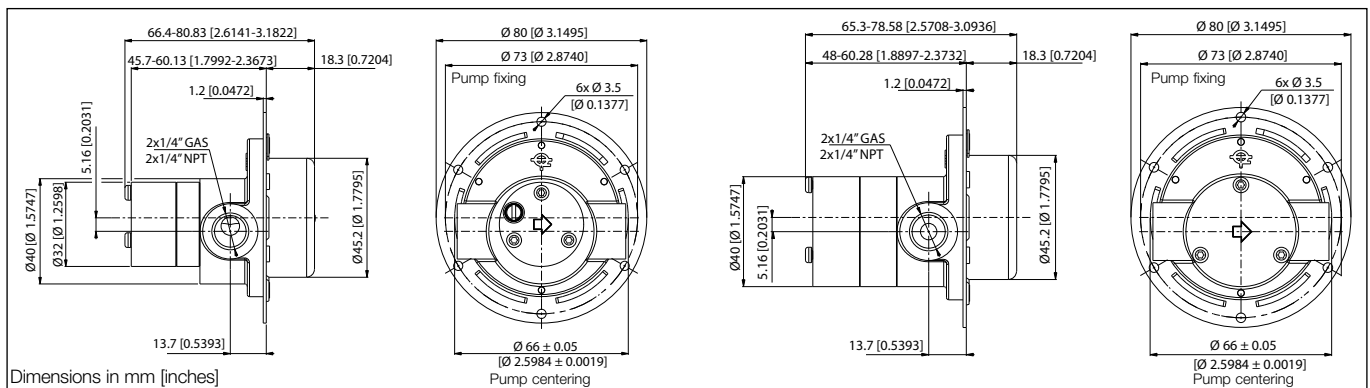

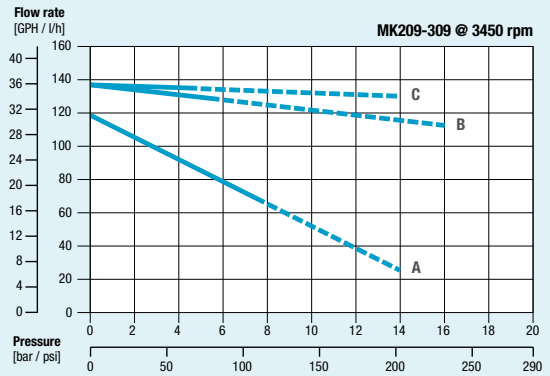
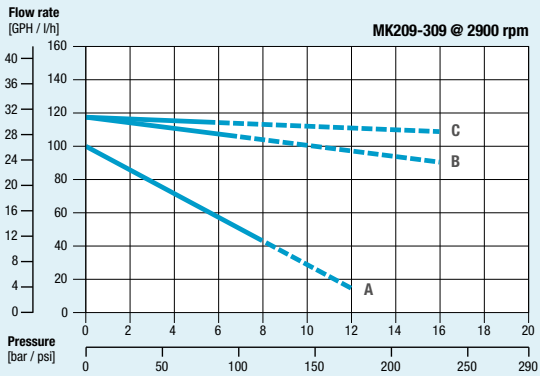
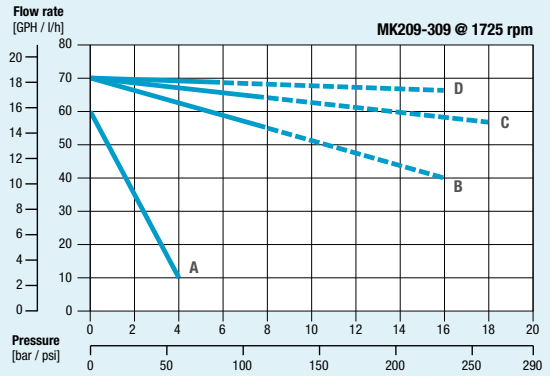
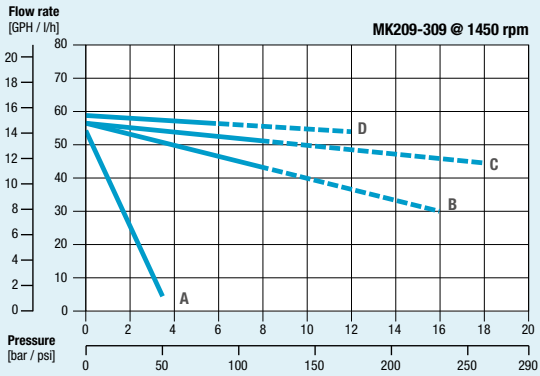

— Operating range with ferrite magnet A = 1 cSt B = 20 cSt C = 75 cSt D = 180 cSt E = 210 cSt
 - - - Operating range with rare earth magnet

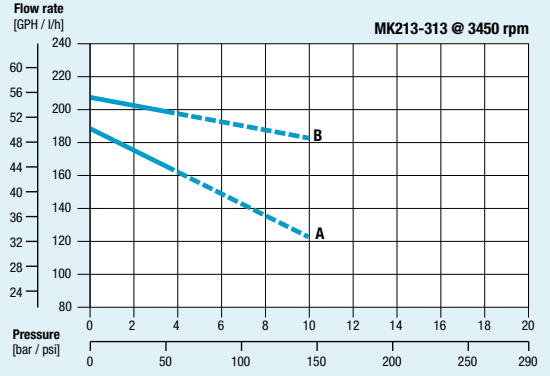
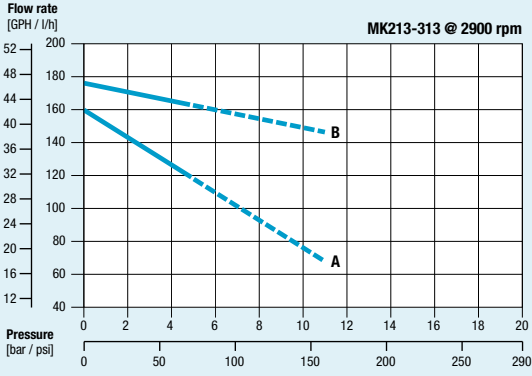
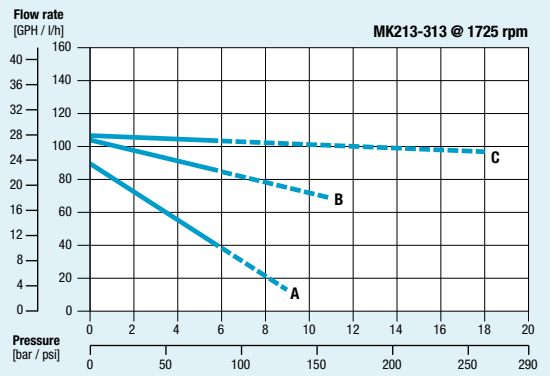
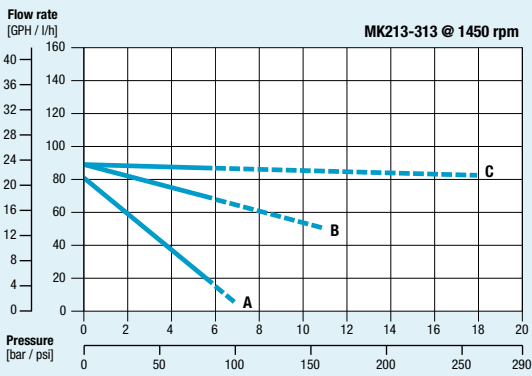

A = 1 cSt B = 20 cSt C = 75 cSt D = 180 cSt E = 210 cSt

Magnet drive gear pumps MK200/MK300/MK500 series

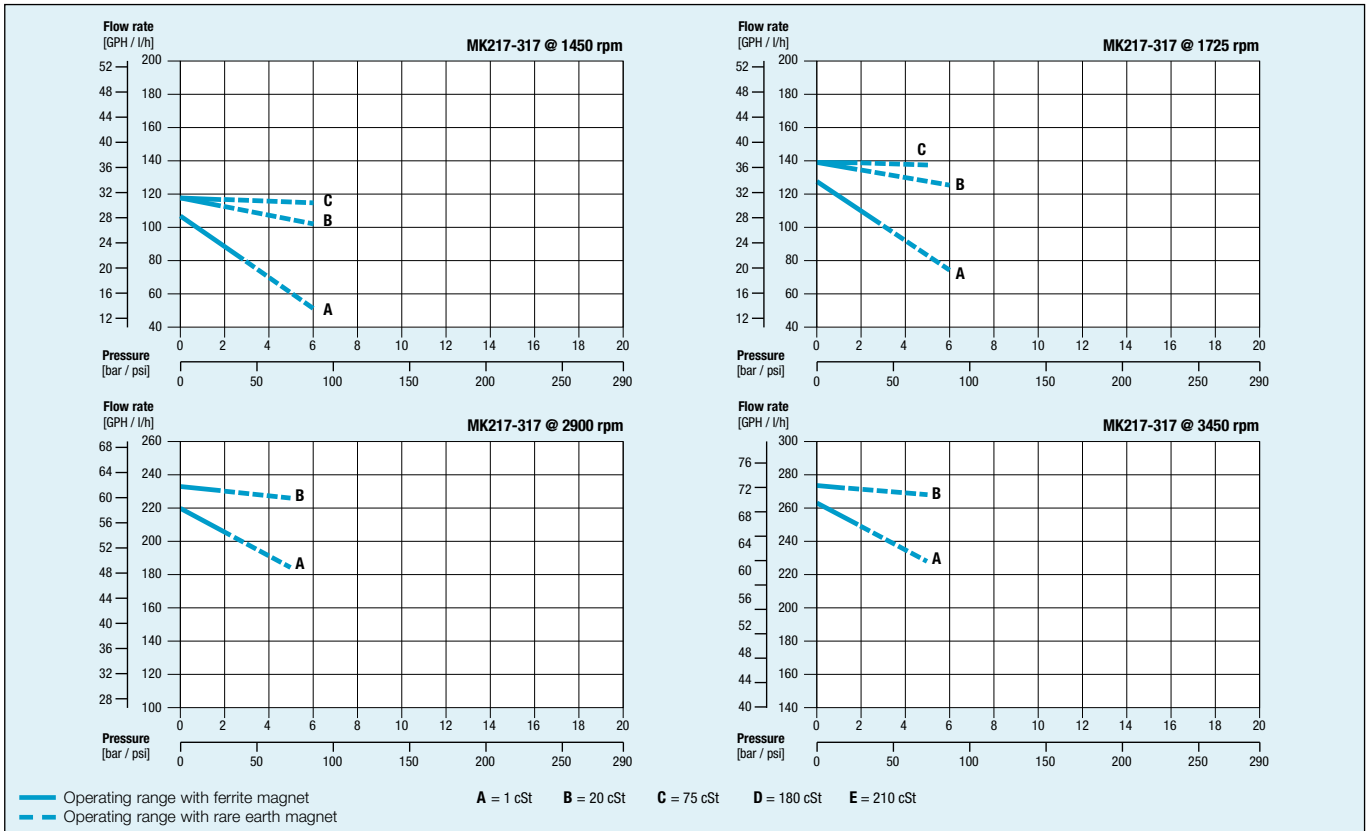

MK213/313 H.V.

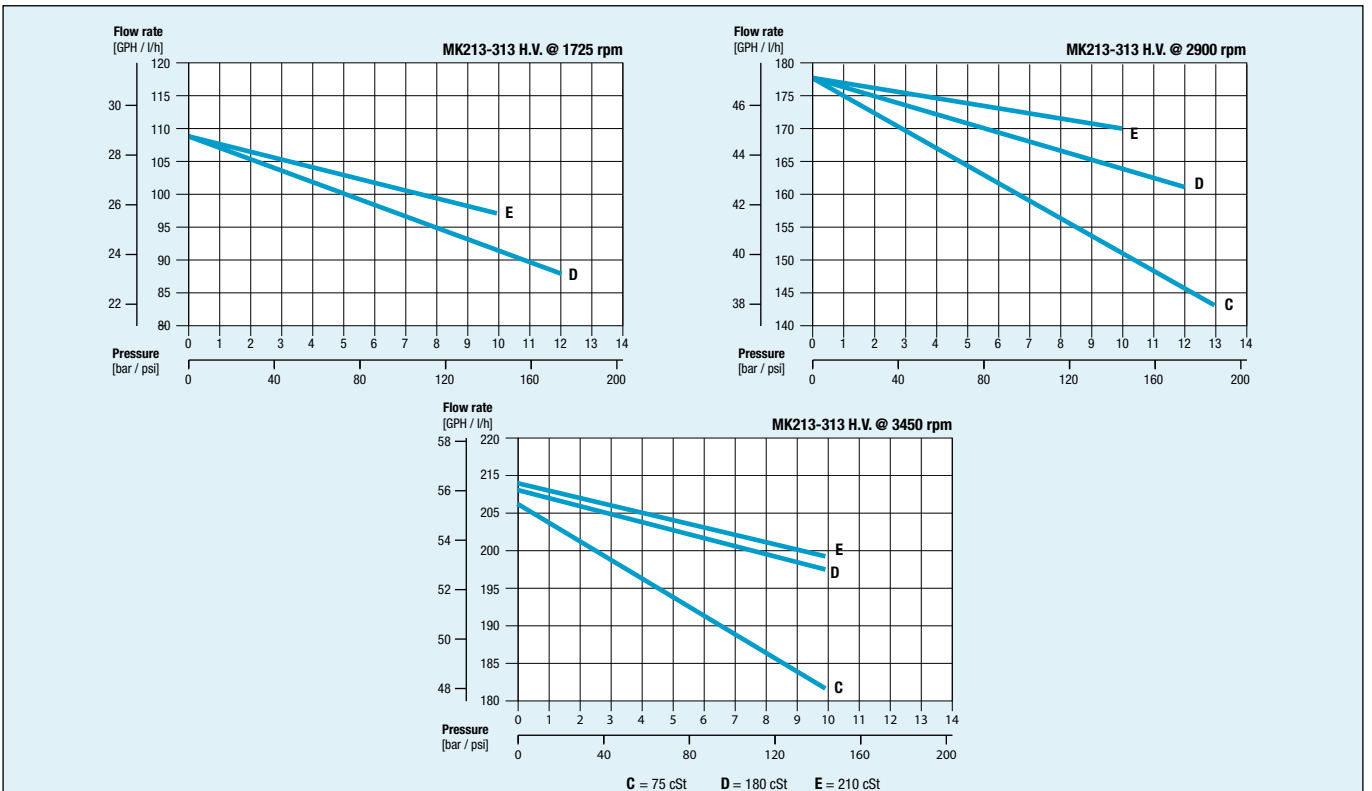

Note: Characteristics with water at 20 °C (68 F) and without relief valve. Fluids different from water must be validated by the Customer. Temperature requirements different from ambient temperature must be mentioned on the order. Different materials are available upon request. Use a filter before the pump inlet no larger than 10 micron

MK217/317/517 H.V.

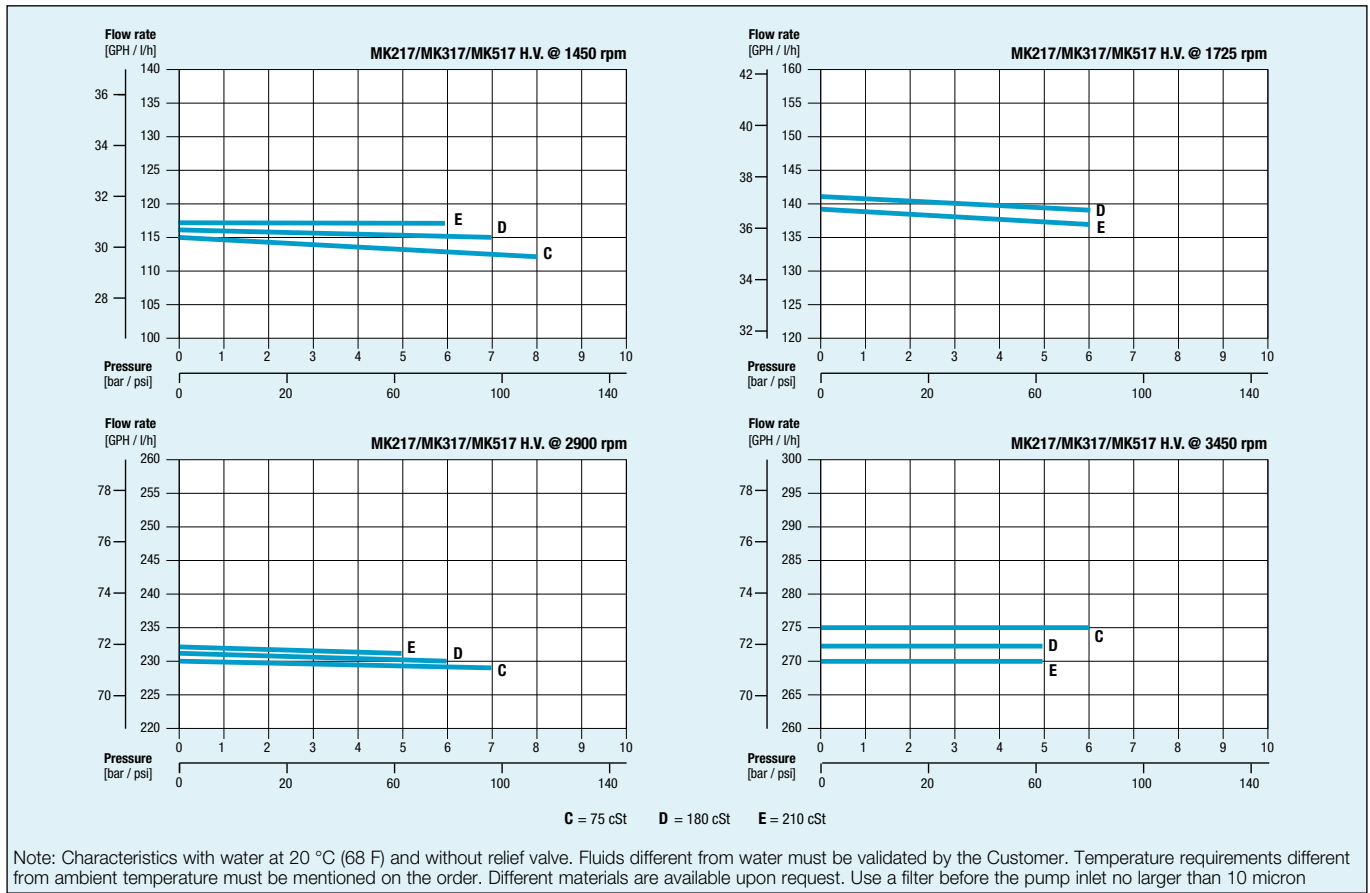

MODEL NUMBER MATRIX

Position	1	2	3	4	5	6	7	8	Customization
Code	MK	3	13	X	E	0	P	N	00000

POS	DESCRIPTION	CODE	POS	DESCRIPTION	CODE
1	Driven magnet	MK = ferrite	5	Type of connections	E = 1/4" GAS F = 1/4" NPT
2	Pump series	2 = PTFE™ flat seal 3/5 = with o-ring	6	Relief valve	0 = without 1 = with
3	Gear width in mm (Nominal displacement)	09 = 9 mm (0.6 ml/rev)	7	Gear material	P = Peek™ T = PTFE™
		13 = 13 mm (0.9 ml/rev)			G = Ceramic Peek™
		17 = 17 mm (1.2 ml/rev)			T = PTFE™ E = EPDM
4	Housing material	X = AISI 316L S = SAF 2205	8	Static seal material	N = NBR S = Silicon
		Y = AISI 303			V = Viton®

Fluid-o-Tech reserves the right to alter the specifications indicated in this catalogue at any time and without prior notice.

Fluid-o-Tech srl
Via Leonardo da Vinci, 40
20094 Corsico, Milano, Italy
Tel. +39 02 9995 01
Fax +39 02 9995 0999
info@fluidotech.it

Fluid-o-Tech Int'l Inc.
161 Atwater St.,
06479 Plantsville CT (USA)
Tel. +1 (860) 276 9270
Fax +1 (860) 620 0193
info@fluid-o-tech.com

Fluid-o-Tech Int'l Inc. Japan
2nd Floor, 4-3-8, Espoir Todoroki,
Todoroki, Setagaya, Tokyo 158-0082
Tel. +81 (0) (3) 6432 1812
Fax +81 (0) (3) 6432 1813
erkkato@fluidotech.jp

Fluid-o-Tech Asia (Shanghai) Co., Ltd.
2/F, Factory building 6 (1), No. 258, Zhijiang Road,
Fengxian District, Shanghai City, Z.P.: 201499 China
Tel. +86 (021) 67100 838
Fax +86 (021) 67100 605
info@fluidotech-asia.com